

PHILIPS

Xitanium

LED driver



Datasheet

LED drivers – track Casambi

Xitanium 36W/a 0.3-1.05A 54V CD 3CW 230V

9290 021 07406

Enabling future-proof LED technology

Xitanium LED drivers are designed to operate LED solutions for general lighting applications.

Benefits

- High reliability underpinned by 5 year warranty
- Application oriented specifications make it suitable for general lighting in retail applications
- Miniaturized design
- Enables wireless light control in existing track lighting installation

Features

- Large operating window suitable for mainstream CoBs
- Easy configuration with SimpleSet
- Compatible with Casambi ecosystem
- 3 Circuit track compatible design
- Black and White housing options

Application

- Retail
- Hospitality

Electrical input data

Specification item	Value	Unit	Condition
Rated input voltage range	220...240	V _{ac}	Performance range
Rated input voltage	230	V _{ac}	
Rated input frequency range	50...60	Hz	Performance range
Rated input current	0.18	A	@ rated output power @ rated input voltage
Max. input current	0.19	A	@ rated output power @ minimum performance input voltage
Rated input power	41	W	@ rated output power @ rated input voltage
Power factor	0.9		@ rated output power @ rated input voltage
Total harmonic distortion	20	%	@ rated output power @ rated input voltage
Efficiency	88	%	@ rated output power @ rated input voltage
Input voltage AC range	198...264	V _{ac}	Operational range
Input frequency AC range	45...66	Hz	Operational range
Isolation input to output	SELV		

Electrical output data

Specification item	Value	Unit	Condition
Regulation method	Constant Current		
Output voltage	24...54	V _{dc}	
Output voltage max.	60	V	Maximum output voltage (rms) (no load)
Output current	0.3...1.05	A	AOC via SimpleSet
Output current tolerance	± 5	%	
Output current ripple LF	≤ 4	%	Ripple = peak / average, < 3kHz
Output power	11...36	W	

Electrical data controls input

Specification item	Value	Unit	Condition
Control method	Wireless		Driver is Casambi ready, controlled by app.
Dimming range	1...100	%	Wireless dimming via the Casambi app

Wiring and Connections

Specification item	Value	Unit	Type
Output wire cross-section	0.2...0.5 / 24...20	mm ² / AWG	WAGO250 (pitch 2.5 mm), solid wire
Output wire strip length	8.5...9.5	mm	
Maximum cable length	0.2	m	Total length of wiring including LED module, one way

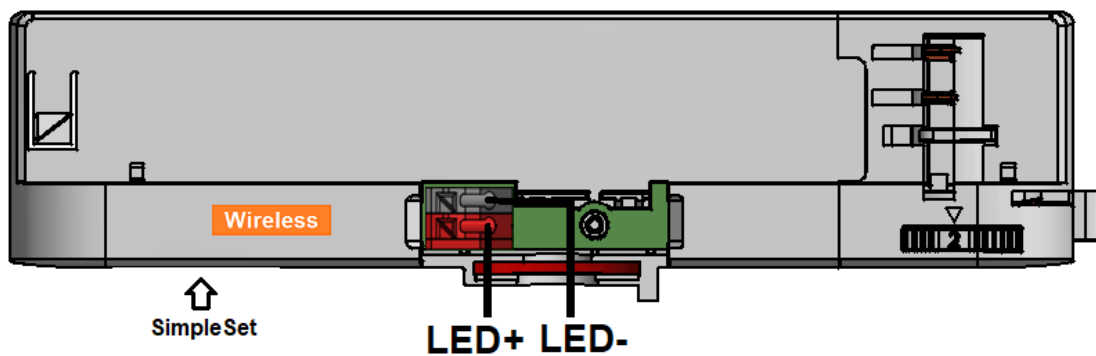

Insulation

Insulation per IEC61347-1	Input	Output
Input		SELV
Output	SELV	

Dimensions and weight

Specification item	Value	Unit	Tolerance (mm)
Length (A1)	234	mm	
Mounting hole distance (A2)	138	mm	
Width (B1)	32	mm	
Height (C1)	43.8	mm	
Height (C2)	13.7	mm	
Mounting hole diameter (D1)	27.3	mm	
Mounting hole diameter (D2)	24.4	mm	
Weight	155	gram	
Housing color	White (RAL 9010)		

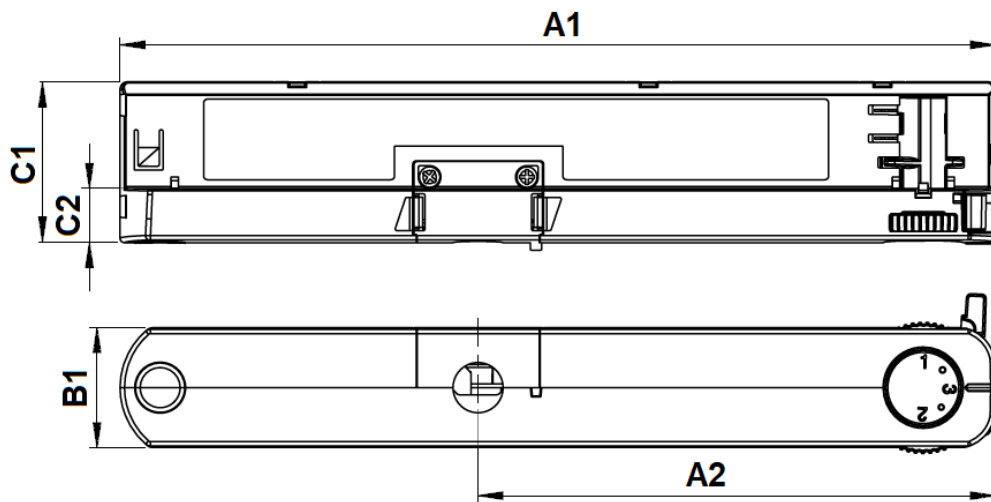

Logistical data

Specification item	Value
Product name	Xitanium 36W/a 0.3-1.05A 54V CD 3CW 230V
EOC	871869973414500
Logistic code 12NC	9290 021 07406
EAN1 (GTIN)	8718699734145
EAN3	8718699734152
Pieces per box	40

Operational temperatures and humidity

Specification item	Value	Unit	Condition
Ambient temperature	-20...+40	°C	Higher ambient temperature allowed as long as T _{case-max} is not exceeded
T _{case-max}	80	°C	Maximum temperature measured at T _{case-point}
T _{case-life}	80	°C	Measured at T _{case-point}
Maximum housing temperature	110	°C	In case of a failure, inherent by design
Relative humidity	10...90	%	Non-condensing

Lifetime

Specification item	Value	Unit	Condition
Driver lifetime	50,000	hours	Measured temperature at Tcase-point is Tcase-life. Maximum failures = 10%

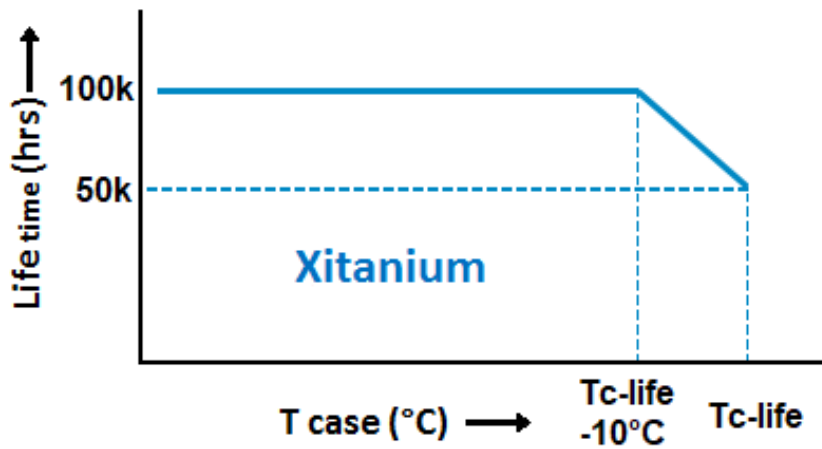

Storage temperature and humidity

Specification item	Value	Unit	Condition
Ambient temperature	-25...+85	°C	
Relative humidity	5...95	%	Non-condensing

Programmable features

Specification item	Available	Default setting	Condition
Set Adjustable Output Current (AOC)	SimpleSet	700 mA	AOC via SimpleSet
OEM Write Protection (OWP)	Yes	OFF	
Luminaire Info	Yes		

Features

Specification item	Value	Condition
Open load protection	Yes	Automatic recovering
Short circuit protection	Yes	Automatic recovering
Over power protection	Yes	Automatic recovering
Hot wiring	No	
Suitable for fixtures with protection class	II	per IEC60598

Inrush current

Specification item	Value	Unit	Condition
Inrush current I_{peak}	9	A	Input voltage 230V
Inrush current T_{width}	22	μ s	Input voltage 230V, measured at 50% I_{peak}
Drivers / MCB 16A type B	≤ 28	pcs	Indicative value



MCB	Rating	Relative number of LED drivers
B	4A	25%
B	6A	40%
B	10A	63%
B	13A	81%
B	16A	100% (stated in datasheet)
B	20A	125%
B	25A	156%
B	32A	200%
B	40A	250%
C	4A	42%
C	6A	63%
C	10A	104%
C	13A	135%
C	16A	170%
C	20A	208%
C	25A	260%
C	32A	340%
C	40A	415%

Driver touch current / protective conductor current

Specification item	Value	Unit	Condition
Typical Touch Current (ins. Class II)	0.7	mA peak	Acc. IEC61347-1. LED module contribution not included

Surge immunity

Specification item	Value	Unit	Condition
Mains surge immunity (diff. mode)	1	kV	Acc. IEC61000-4-5. 2 Ohm, 1.2/50us, 8/20us
Mains surge immunity (comm. mode)	2	kV	Acc. IEC61000-4-5. 12 Ohm, 1.2/50us, 8/20us

Application Info

Specification item	Value
Approval marks	CE / EAC / ENEC / SELV
Ingress Protection classification (IP)	20

Graphs

Operating window

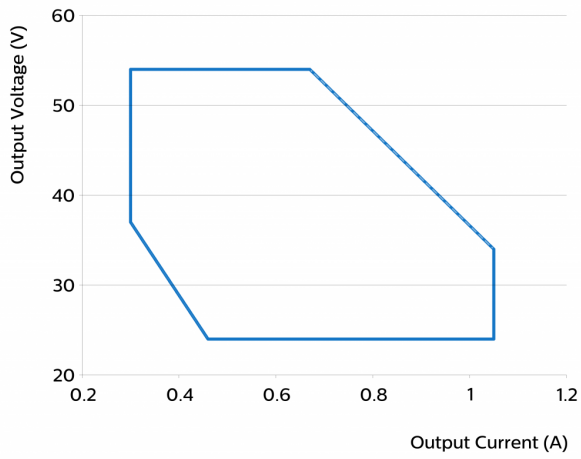

Power factor versus output power

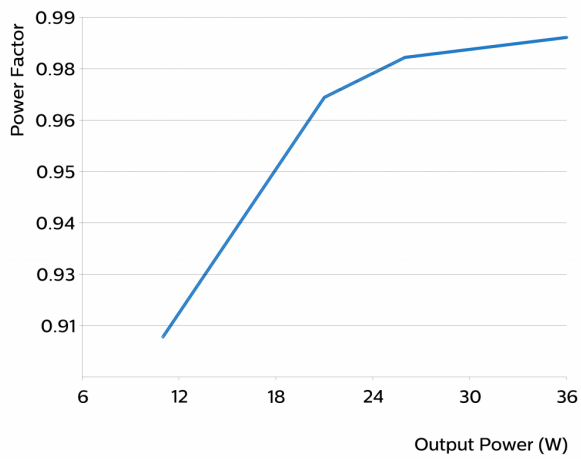

Efficiency versus output power

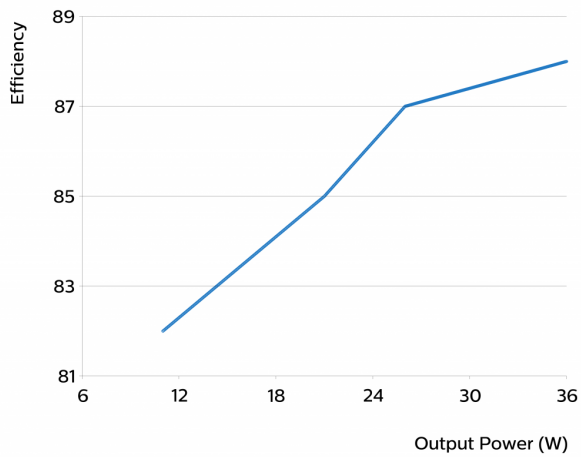

THD versus output power

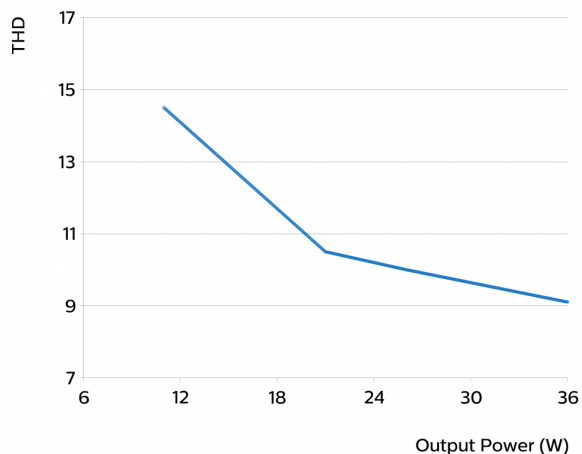

Notes

To configure and control this driver download the Casambi app.

The products sold by Signify may rely on the availability and correct functioning of products, components and/or services from third-party product suppliers and service providers, including cloud hosting services and the connectivity and communication services from mobile operators. Signify has no responsibility or any liability whatsoever with respect thereto, including but not limited to (i) downtime, (ii) unavailability, (iii) degradation of the functionality of the products due to any failure, update of or modification by any third-party service providers, e.g., mobile operator's sunset/shutdown of a connectivity or communication technology/network, or (iv) the transfer of data over networks or communication facilities operated by third parties.



©2020 Signify Holding, IBRS 10461, 5600 VB, NL. All rights reserved.

The information provided herein is subject to change without notice. Signify does not give any representation or warranty as to the accuracy or completeness of the information included herein and shall not be liable for any action in reliance thereon. The information presented in this document is not intended as any commercial offer and does not form part of any quotation or contract, unless otherwise agreed by Signify.

Philips and the Philips Shield Emblem are registered trademarks of Koninklijke Philips N.V. All other trademarks are owned by Signify Holding or their respective owners.

Date of release: July 7, 2020 v2

www.philips.com/oem